

3V3Sheet  
3V3Sheet.sch

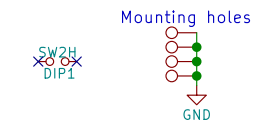

Dries007.net	
Sheet: /	
File: MainSheet.sch	
<b>Title: Dries007 AVR Devboard</b>	
Size: A4	Date: 2018-02-13
KiCad E.D.A. kicad 4.0.7	Rev: DRAFT 1
	Id: 1/2

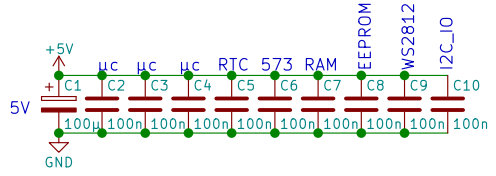
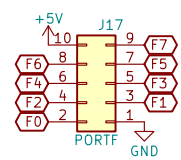
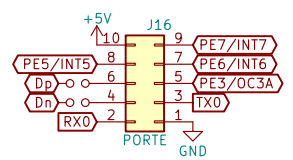
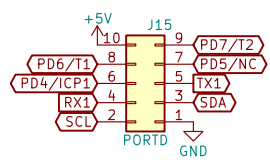
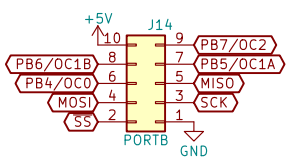
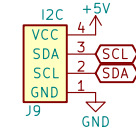
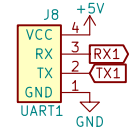
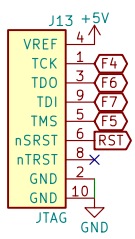
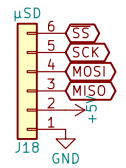
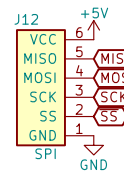
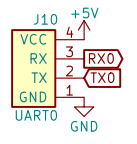
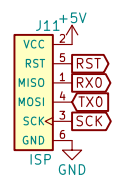
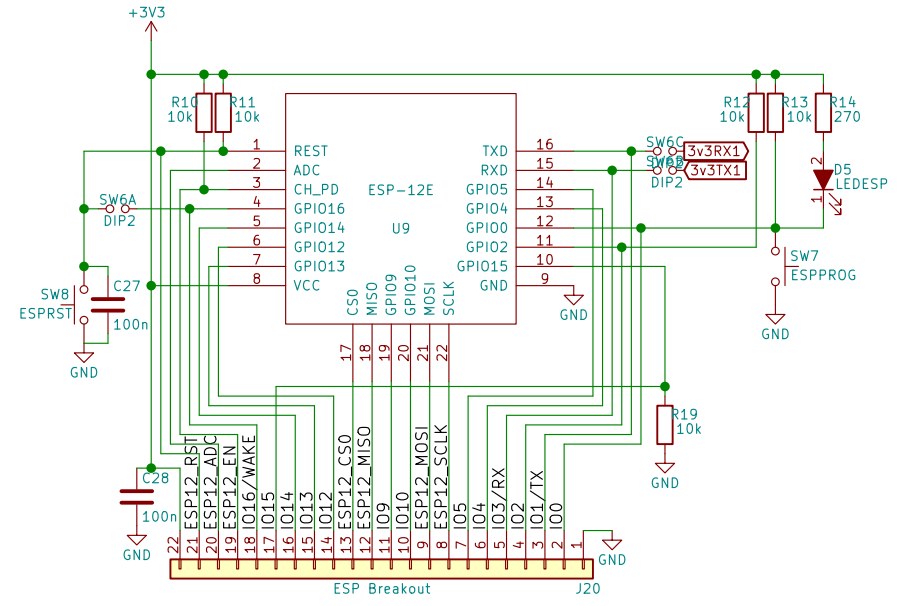
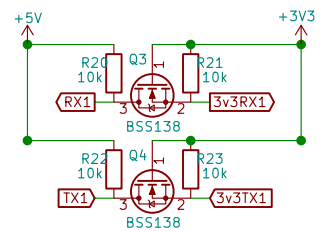
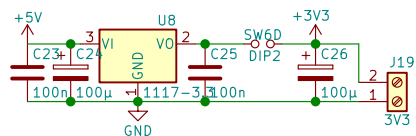

Dries007.net

Sheet: /3V3Sheet/  
File: 3V3Sheet.sch

**Title: Dries007 AVR Devboard**

Size: A4 Date: 2018-02-13  
KiCad E.D.A. kicad 4.0.7

Rev: DRAFT 1  
Id: 2/2



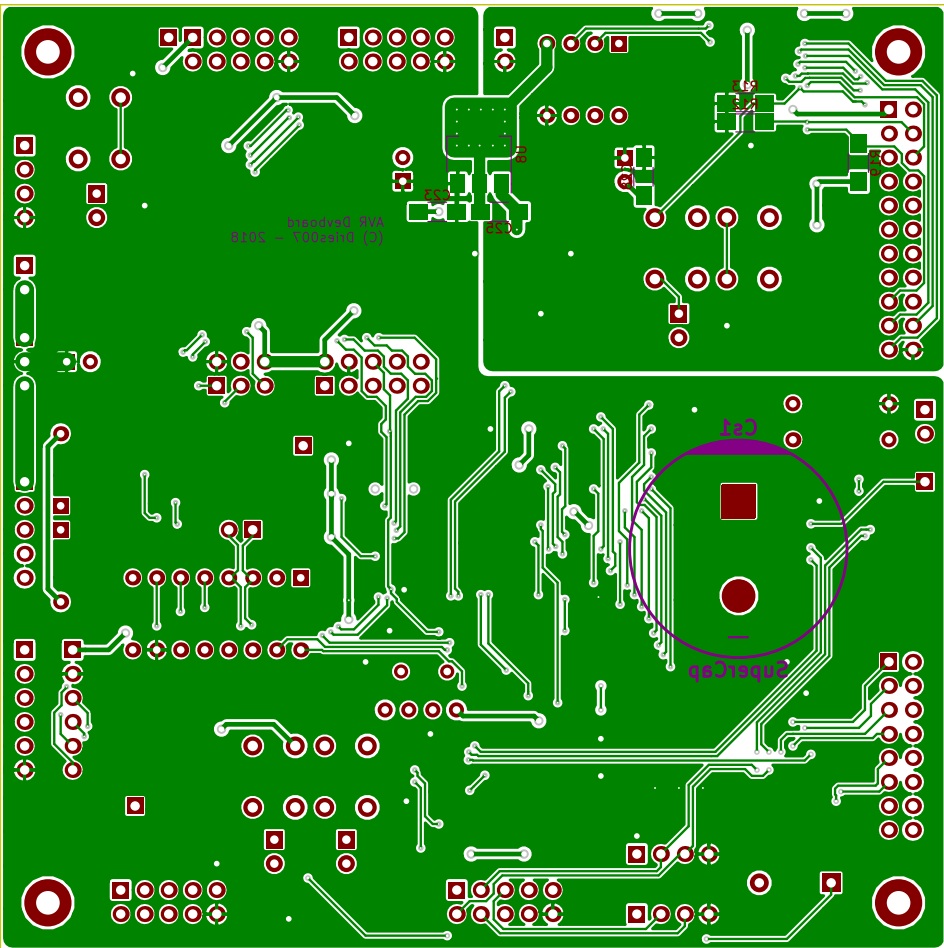

0201  
0603

0201

0603